

FEATURE

- Low gate charge
- Low C_{iss}
- Fast switching
- 100% avalanche tested
- Improved dv/dt capability

Maximum output current
 I_{OM} : 0.5 A

Output voltage
 V_O : 9V

Continuous total dissipation
 P_D : 1.25 W ($T_a = 25^\circ\text{C}$)

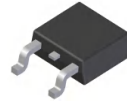

ABSOLUTE MAXIMUM RATINGS (Operating temperature range applies unless otherwise specified)

Parameter	Symbol	Value	Unit
Input Voltage	V_i	25	V
Operating Junction Temperature Range	T_{OPR}	0-+125	$^\circ\text{C}$
Storage Temperature Range	T_{STG}	-65-+150	$^\circ\text{C}$

ELECTRICAL CHARACTERISTICS AT SPECIFIED VIRTUAL JUNCTION TEMPERATURE

Parameter	Symbol	Test conditions	Min	Typ	Max	Unit
Output Voltage	V_O	25°C	8.65	9	9.35	V
		$11.5 \leq V_i \leq 24\text{V}, I_o = 5\text{mA} - 350\text{mA}, P_o \leq 15\text{W}$ $0-125^\circ\text{C}$	8.55	9	9.45	V
Load Regulation	ΔV_O	$I_o = 5\text{mA} - 500\text{mA}$ 25°C		20	180	mV
		$I_o = 5\text{mA} - 200\text{mA}$ 25°C		10	90	mV
Line Regulation	ΔV_O	$11.5\text{V} \leq V_i \leq 26\text{V}, I_o = 200\text{mA}$ 25°C		6	100	mV
		$12\text{V} \leq V_i \leq 26\text{V}, I_o = 200\text{mA}$ 25°C		2	50	mV
Quiescent Current	I_q	25°C		4.6	6	mA
Quiescent Current Change	ΔI_q	$11.5\text{V} \leq V_i \leq 26\text{V}, I_o = 200\text{mA}$ $0-125^\circ\text{C}$			0.8	mA
		$5\text{mA} \leq I_o \leq 350\text{mA}$ $0-125^\circ\text{C}$			0.5	mA
Output Noise Voltage	V_N	$10\text{Hz} \leq f \leq 100\text{KHz}$ 25°C		60		μV
Ripple Rejection	RR	$13 \leq V_i \leq 23\text{V}, f = 120\text{Hz}, I_o = 300\text{mA}$ $0-125^\circ\text{C}$	56	80		dB
Dropout Voltage	V_d	$I_o = 350\text{mA}$ 25°C		2		V
Short Circuit Current	I_{sc}	$V_i = 16\text{V}$ 25°C		250		mA
Peak Current	I_{pk}	25°C		0.5		A

TYPICAL APPLICATION

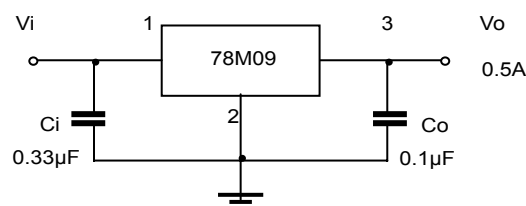

RATING AND CHARACTERISTIC CURVES

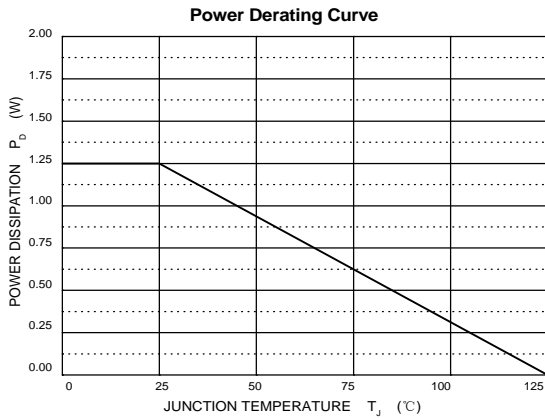
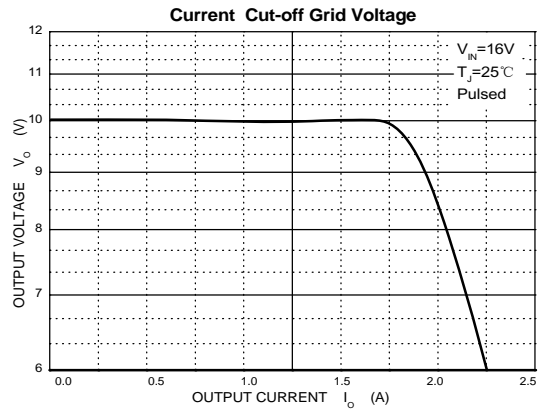
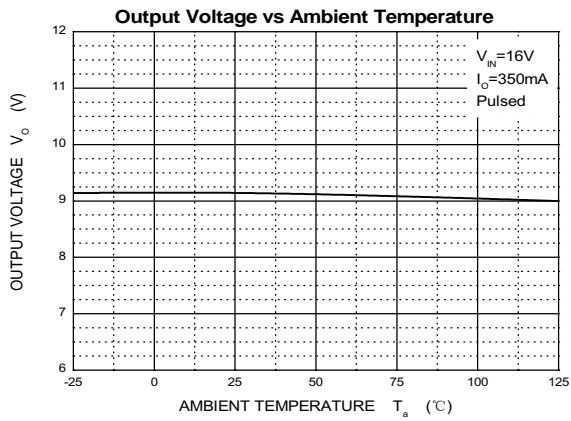
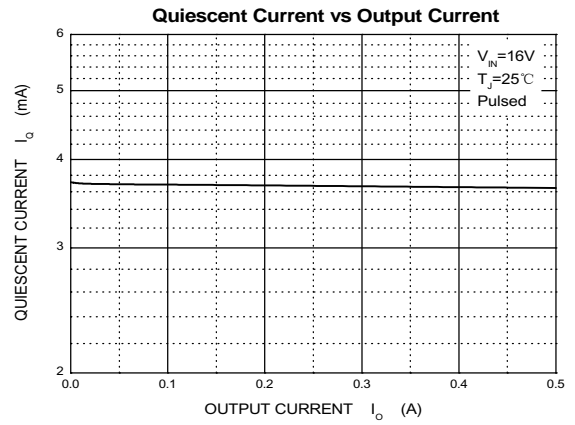
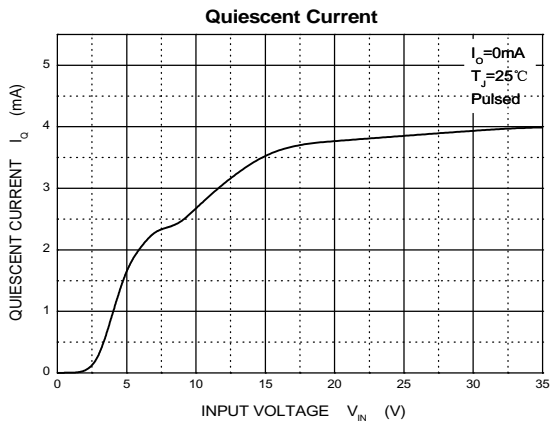
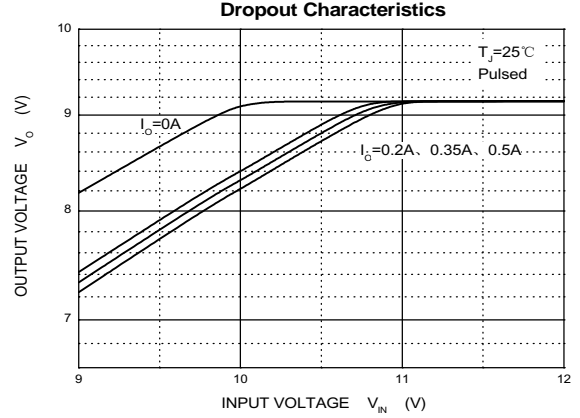
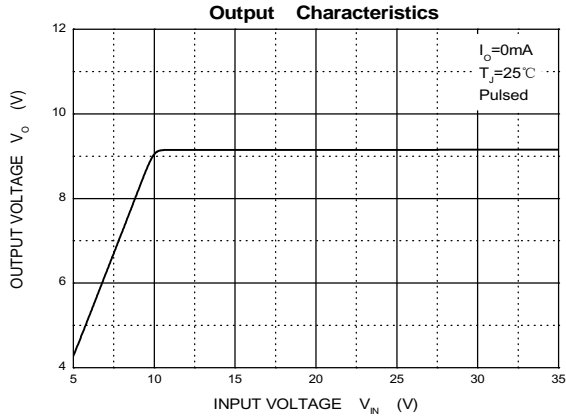

Soldering parameters

Reflow Condition		Pb-Free assembly (see as below)
Pre Heat	-Temperature Min ($T_{s(min)}$)	+150 °C
	-Temperature Max ($T_{s(max)}$)	+200 °C
	-Time (Min to Max) (ts)	60-180 secs.
Average ramp up rate (Liquid us Temp (T_L) to peak)		3 °C/sec. Max
$T_{s(max)}$ to T_L - Ramp-up Rate		3 °C/sec. Max
Reflow	-Temperature (T_L) (Liquid us)	+217 °C
	-Temperature (t_L)	60-150 secs.
Peak Temp (T_P)		+260(+0/-5) °C
Time within 5 °C of actual Peak Temp (t_p)		30 secs. Max
Ramp-down Rate		6 °C/sec. Max
Time 25 °C to Peak Temp (T_P)		8 min. Max
Do not exceed		+260 °C



Package Dimensions & Suggested Pad Layout

TO-252

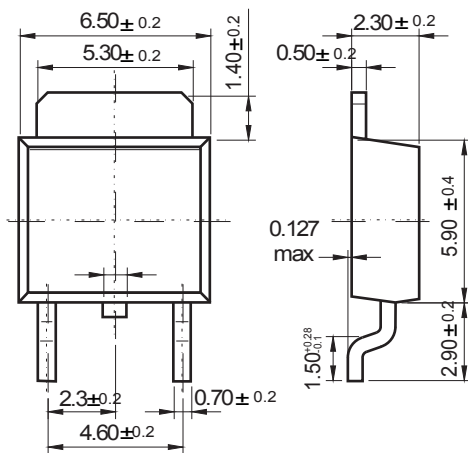

Dimensions in inches and (millimeters)

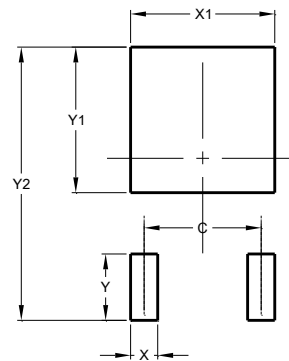

Dimensions	Value (in mm)
C	4.55
X	1.50
X1	5.80
Y	2.70
Y1	6.00
Y2	10.90

Tape & reel specification

Tape		Symbol	Dimension (mm)
		P0	4.00±0.20
		P1	8.00±0.20
		P2	2.00±0.20
		D0	1.55±0.15
		D1	1.55±0.20
		E	1.75±0.20
		F	7.50±0.20
		W	16.00±0.20
		A0	7.10±0.20
		B0	10.50±0.20
		K0	2.70±0.20
		T	0.30±0.10
		D2	330.0±5.0
		D3	100.0±4.0
W1	20.0±5.0		
W2	25.0±5.0		
I	13.0±2.0		
Quantity: 2500PCS			

13" Reel

