

FEATURE

Maximum output current

I_{OM} : 0.1 A

Output voltage

V_o : 9 V

Continuous total dissipation

P_D : 0.5W

SOT-89-3L

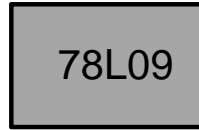
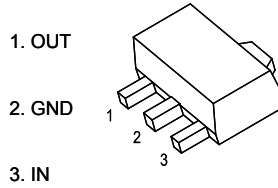

ABSOLUTE MAXIMUM RATINGS (Operating temperature range applies unless otherwise specified)

Parameter	Symbol	Value	Units
Input Voltage	V_I	30	V
Operating Junction Temperature Range	T_{OPR}	0~+150	°C
Storage Temperature Range	T_{STG}	-55~+150	°C

ELECTRICAL CHARACTERISTICS AT SPECIFIED VIRTUAL JUNCTION TEMPERATURE

Parameter	Symbol	Test conditions	Min	Typ	Max	Unit	
Output voltage	V_o	25°C	8.64	9.0	9.36	V	
		0-125°C	$12V \leq V_I \leq 24V, I_o = 1mA-40mA$	8.55	9.0	9.45	V
			$I_o = 1mA-70mA$	8.55	9.0	9.45	V
Load Regulation	ΔV_o	$I_o = 1mA-100mA$	25°C	19	90	mV	
		$I_o = 1mA-40mA$	25°C	11	40	mV	
Line regulation	ΔV_o	$12V \leq V_I \leq 24V$	25°C	45	175	mV	
		$13V \leq V_I \leq 24V$	25°C	40	125	mV	
Quiescent Current	I_q	25°C	4.1	6.0	mA		
Quiescent Current Change	ΔI_q	$13V \leq V_I \leq 24V$	0-125°C		1.5	mA	
	ΔI_q	$1mA \leq I_o \leq 40mA$	0-125°C		0.1	mA	
Output Noise Voltage	V_N	10Hz ≤ f ≤ 100KHz	25°C	58		uV	
Ripple Rejection	RR	$15V \leq V_I \leq 25V, f = 120Hz$	0-125°C	45		dB	
Dropout Voltage	V_d	25°C		1.7		V	

TYPICAL APPLICATION

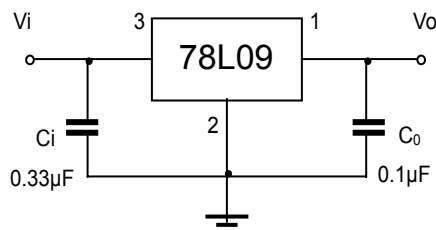

Note: Bypass capacitors are recommended for optimum stability and transient response and should be located as close as possible to the regulators.

RATING AND CHARACTERISTIC CURVES

Output Characteristics

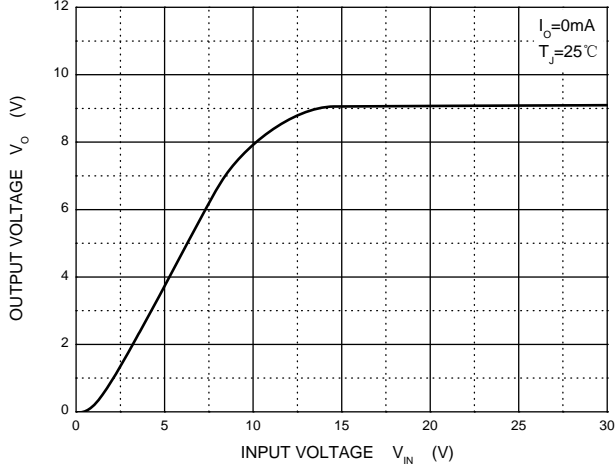

Dropout Characteristics

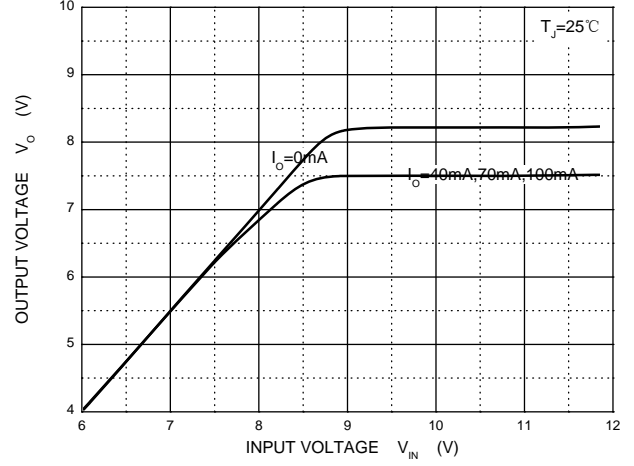

Quiescent Current vs Input Voltage

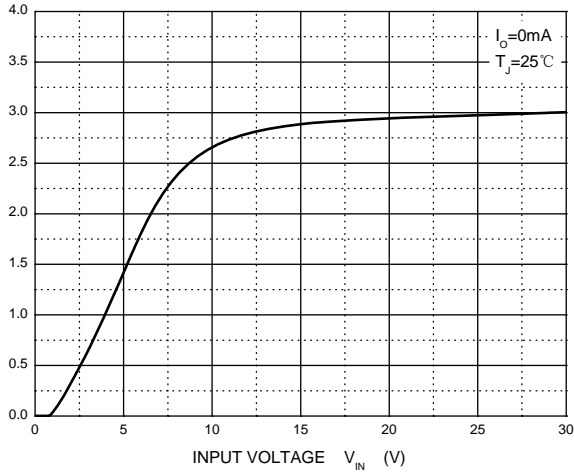

Current Cut-off Grid Voltage

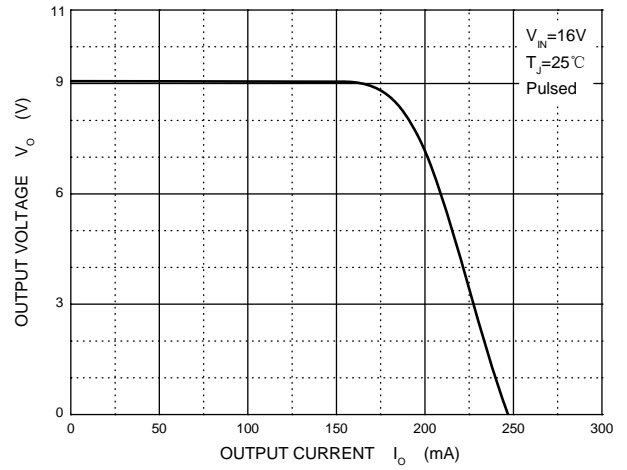

Output Voltage vs Junction Temperature

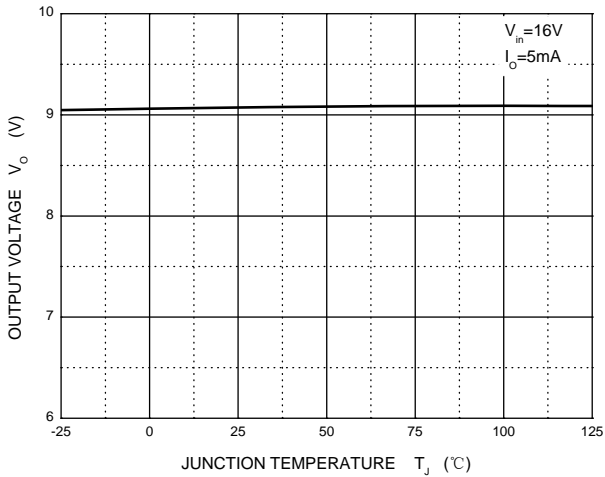

Power Derating Curve

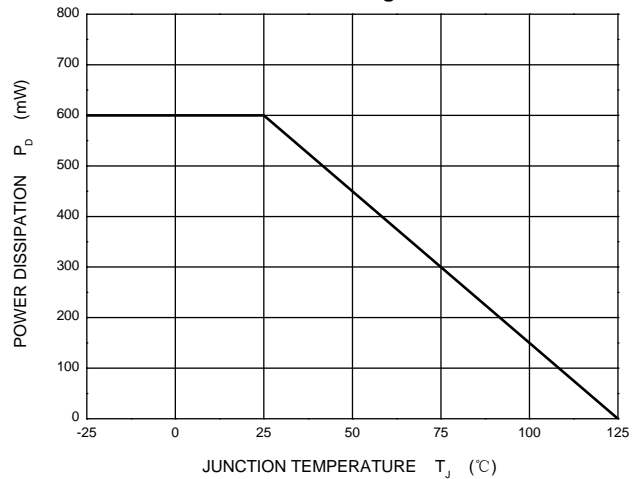

Soldering parameters

Reflow Condition		Pb-Free assembly (see as below)
Pre Heat	-Temperature Min ($T_{s(min)}$)	+150 °C
	-Temperature Max ($T_{s(max)}$)	+200 °C
	-Time (Min to Max) (ts)	60-180 secs.
Average ramp up rate (Liquid us Temp (T_L) to peak)		3 °C/sec. Max
$T_{s(max)}$ to T_L - Ramp-up Rate		3 °C/sec. Max
Reflow	-Temperature (T_L) (Liquid us)	+217 °C
	-Temperature (t_L)	60-150 secs.
Peak Temp (T_P)		+260(+0/-5) °C
Time within 5 °C of actual Peak Temp (t_p)		30 secs. Max
Ramp-down Rate		6 °C/sec. Max
Time 25 °C to Peak Temp (T_P)		8 min. Max
Do not exceed		+260 °C

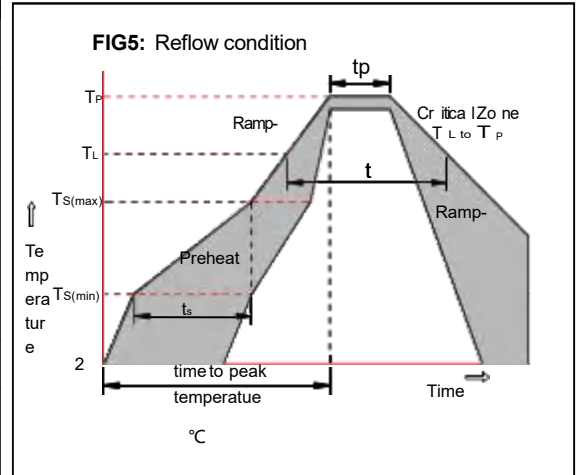

Package Dimensions & Suggested Pad Layout

SOT89

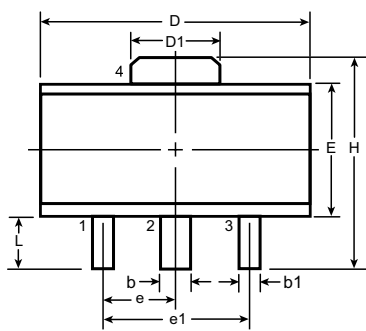

Top View

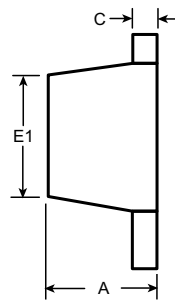

Side View

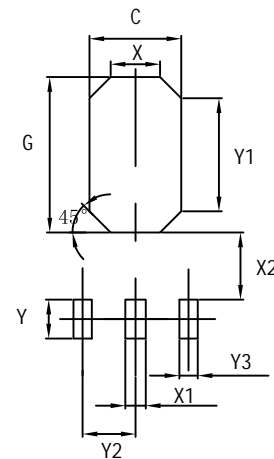

Symbol	A	b	b1	C	D	D1	E	E1	e	e1	H	L	
Dimensions (mm)	MIN	1.40	0.44	0.36	0.3	4.40	1.50	2.29	2.00 ^f	1.50	3.00	3.94	0.89
	NOM	-	-	-	-	-	-	-	-	BSC	BSC	-	-
	MAX	1.60	0.56	0.48	0.5	4.60	1.75	2.60	2.29	-	-	4.25	1.20

Dimensions	Value (in mm)
C	2.50
G	3.60
X	1.40
X1	0.90
X2	0.90
Y	1.40
Y1	2.60
Y2	1.50
Y3	0.90

Tape & reel specification

Tape		Symbol	Dimension (mm)		
		P0	4.00±0.20		
		P1	8.00±0.20		
		P2	2.00±0.20		
		D0	1.60±0.20		
		D1	1.60±0.20		
		E	1.75±0.20		
		F	7.50±0.15		
		W	16.00±0.20		
		A0	6.30±0.20		
		B0	8.25±0.20		
		K0	2.60±0.20		
		T	0.23±0.10		
		13" Reel		D2	180.0±5.0
				D3	60Min.
				D4	R32.0±2.0
				G	R86.5±2.0
H	R30.0±2.0				
I	13.0±2.0				
W1	13.20±2.0				
W2	16.50±2.0				
Quantity: 1000PCS					