

FEATURES

- * Ideal for surface mount applications
- * Easy pick and place
- * Built-in strain relief
- * Low forward voltage drop

MECHANICAL DATA

- * Case: Molded plastic
- * Epoxy: UL 94V-0 rate flame retardant
- * Metallurgically bonded construction
- * Polarity: Color band denotes cathode end
- * Mounting position: Any
- * Weight: 0.063 grams



VOLTAGE RANGE

60 Volts
CURRENT
5.0 Ampere

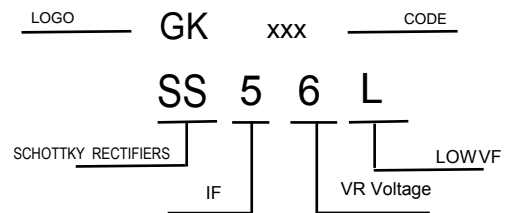

MAXIMUM RATINGS AND ELECTRICAL CHARACTERISTICS

Rating 25°C ambient temperature unless otherwise specified.
Single phase half wave, 60Hz, resistive or inductive load.
For capacitive load, derate current by 20%.

| TYPE NUMBER | SS56L | UNITS |
|---|------------|-------|
| Maximum Recurrent Peak Reverse Voltage | 60 | V |
| Maximum RMS Voltage | 42 | V |
| Maximum DC Blocking Voltage | 60 | V |
| Maximum Average Forward Rectified Current See Fig. 1 | 5.0 | A |
| Peak Forward Surge Current, 8.3 ms single half sine-wave superimposed on rated load (JEDEC method) | 120 | A |
| Maximum Instantaneous Forward Voltage at 2.0A | 0.55 | V |
| Maximum DC Reverse Current at Rated DC Blocking Voltage | 0.15 30 | mA |
| Typical Junction Capacitance (Note1) | 370 | pF |
| Typical Thermal Resistance R _{JA} (Note 2) | 88 | °C/W |
| Operating Temperature Range T _J | -55 → +125 | °C |
| Storage Temperature Range T _{stg} | -55 → +150 | °C |

NOTES:

1. Measured at 1MHz and applied reverse voltage of 4.0V D.C.
2. P.C.B. mounted with 0.2" x 0.2" (5.0 mm x 5.0 mm) copper pad areas

RATING AND CHARACTERISTIC CURVES

FIG.1-TYPICAL FORWARD CURRENT DERATING CURVE

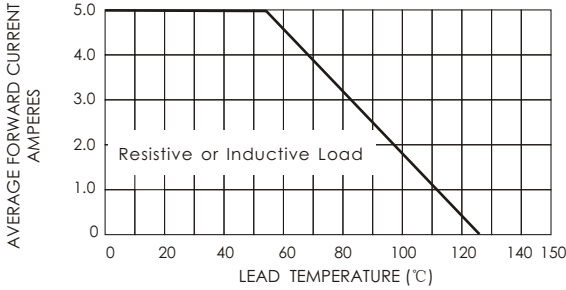

FIG.2-TYPICAL FORWARD CHARACTERISTICS

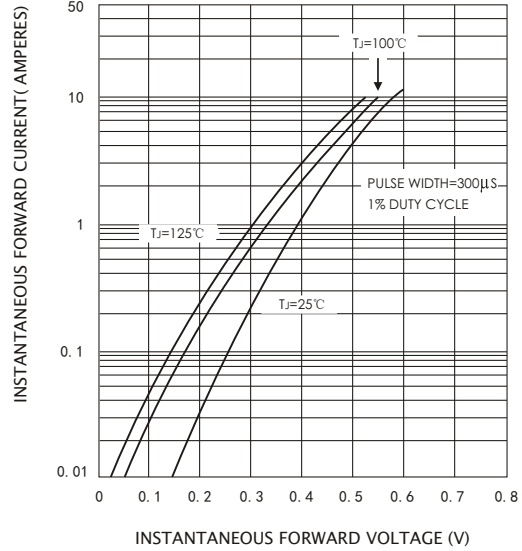

FIG.3 - TYPICAL REVERSE CHARACTERISTICS

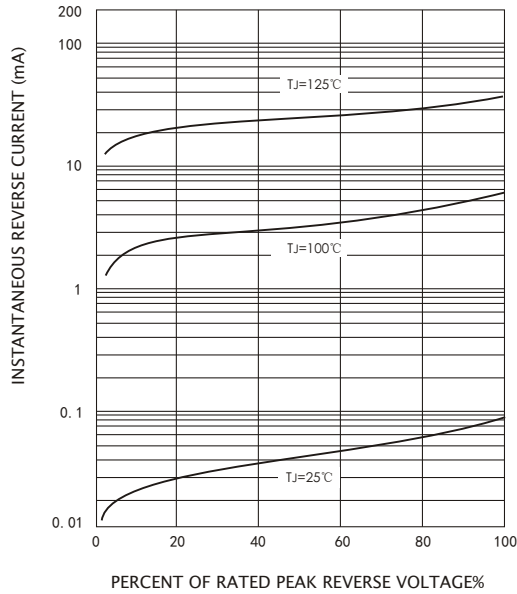

FIG.4-MAXIMUM NON-REPETITIVE FORWARD SURGE CURRENT

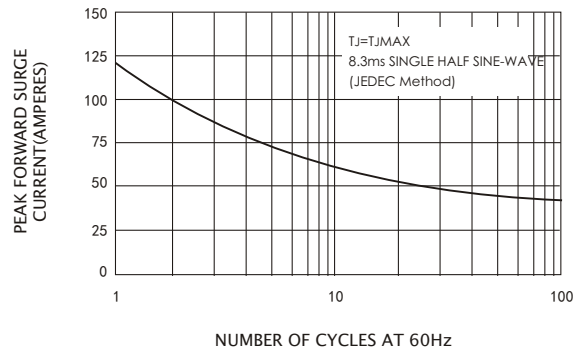
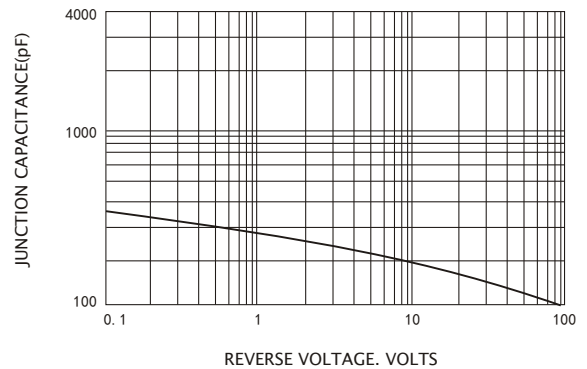

FIG.5-TYPICAL JUNCTION CAPACITANCE



Soldering parameters

| Reflow Condition | | Pb-Free assembly (see as below) |
|---|-----------------------------------|------------------------------------|
| Pre Heat | -Temperature Min ($T_{s(min)}$) | +150 °C |
| | -Temperature Max($T_{s(max)}$) | +200 °C |
| | -Time (Min to Max) (ts) | 60-180 secs. |
| Average ramp up rate (Liquid us Temp (T_L) to peak) | | 3 °C/sec. Max |
| $T_{s(max)}$ to T_L - Ramp-up Rate | | 3 °C/sec. Max |
| Reflow | -Temperature(T_L)(Liquid us) | +217 °C |
| | -Temperature(t_L) | 60-150 secs. |
| Peak Temp (T_P) | | +260(+0/-5) °C |
| Time within 5 °C of actual Peak Temp (t_p) | | 30 secs. Max |
| Ramp-down Rate | | 6 °C/sec. Max |
| Time 25 °C to Peak Temp (T_P) | | 8 min. Max |
| Do not exceed | | +260 °C |



Package Dimensions & Suggested Pad Layout

SMA

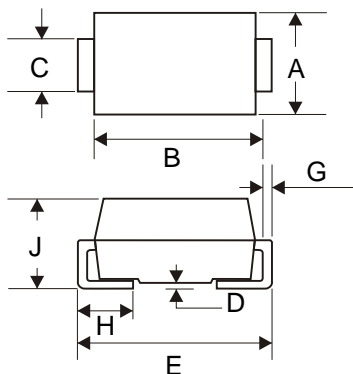

| SMA | | |
|----------------------|------|------|
| Dim | Min | Max |
| A | 2.40 | 2.79 |
| B | 3.99 | 4.50 |
| C | 1.32 | 1.47 |
| D | - | 0.20 |
| E | 4.93 | 5.28 |
| G | 0.15 | 0.31 |
| H | 0.76 | 1.52 |
| J | 1.98 | 2.29 |
| All Dimensions in mm | | |

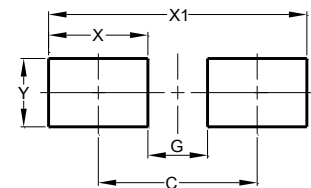

| Dimensions | Value (in mm) |
|------------|---------------|
| C | 4.20 |
| G | 1.90 |
| X | 2.30 |
| X1 | 6.50 |
| Y | 2.00 |

Tape & reel specification

| Tape | | Symbol | Dimension (mm) |
|--------------------------|-----------|-------------------|----------------|
| | | P0 | 4.00±0.20 |
| | | P1 | 4.00±0.20 |
| | | P2 | 2.00±0.20 |
| | | D0 | 1.60±0.20 |
| | | D1 | 1.60±0.20 |
| | | E | 1.75±0.20 |
| | | F | 5.50±0.15 |
| | | W | 12.00±0.25 |
| | | A0 | 2.75±0.20 |
| | | B0 | 5.25±0.20 |
| | | K0 | 2.45±0.25 |
| T | 0.20±0.10 | | |
| <p>7" Reel</p> | | D2 | 176.0±5.0 |
| | | D3 | 55.0Min. |
| | | D4 | 14.0±2.5 |
| | | W1 | 14.0±2.5 |
| <p>13" Reel</p> | | Quantity: 2000PCS | |
| | | D8 | 330.0±5.0 |
| | | D9 | 73.0Min. |
| | | D10 | 14.0±2.5 |
| | | W3 | 14.0±2.5 |
| <p>Quantity: 5000PCS</p> | | | |