

**VOLTAGE RANGE**

40 Volts

**CURRENT**

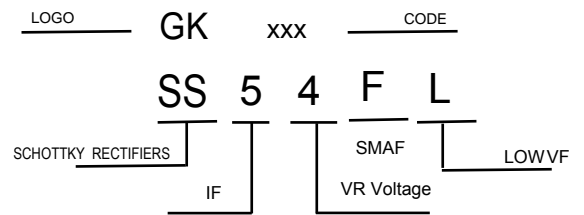
5.0 Ampere

**FEATURES**

- \* Ideal for surface mount applications
- \* Easy pick and place
- \* Built-in strain relief
- \* Low forward voltage drop

**MECHANICAL DATA**

- \* Case: Molded plastic
- \* Epoxy: UL 94V-0 rate flame retardant
- \* Metallurgically bonded construction
- \* Polarity: Color band denotes cathode end
- \* Mounting position: Any
- \* Weight: 0.063 grams



**MAXIMUM RATINGS AND ELECTRICAL CHARACTERISTICS**

Rating 25°C ambient temperature unless otherwise specified.  
Single phase half wave, 60Hz, resistive or inductive load.  
For capacitive load, derate current by 20%.

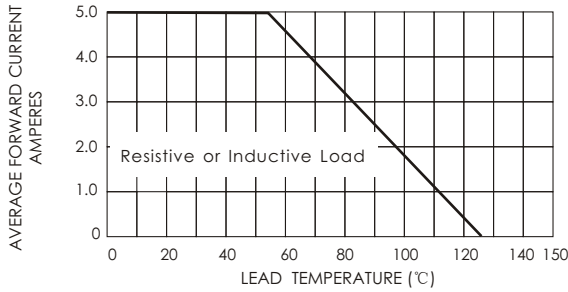
TYPE NUMBER	SS54FL	UNITS
Maximum Recurrent Peak Reverse Voltage	40	V
Maximum RMS Voltage	28	V
Maximum DC Blocking Voltage	40	V
Maximum Average Forward Rectified Current See Fig. 1	5.0	A
Peak Forward Surge Current, 8.3 ms single half sine-wave superimposed on rated load (JEDEC method)	120	A
Maximum Instantaneous Forward Voltage at 2.0A	0.46	V
Maximum DC Reverse Current at Rated DC Blocking Voltage	1.0 50	mA mA
Typical Junction Capacitance (Note1)	380	pF
Typical Thermal Resistance R <sub>JA</sub> (Note 2)	88	°C/W
Operating Temperature Range T <sub>J</sub>	-55 to +125	°C
Storage Temperature Range T <sub>stg</sub>	-55 to +150	°C

**NOTES:**

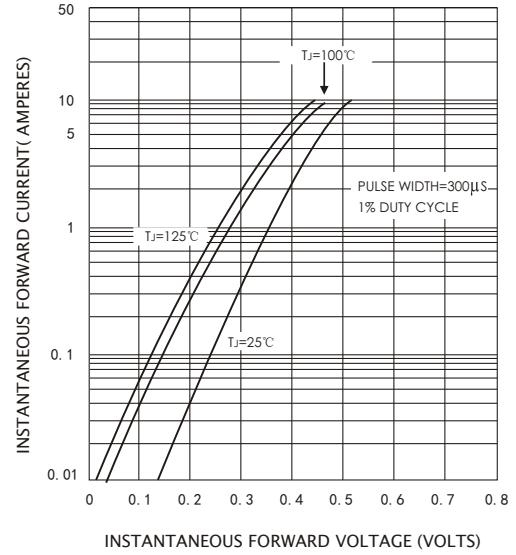
1. Measured at 1MHz and applied reverse voltage of 4.0V D.C.
2. P.C.B. mounted with 0.2" x 0.2" (5.0 mm x 5.0 mm) copper pad areas

**RATING AND CHARACTERISTIC CURVES**

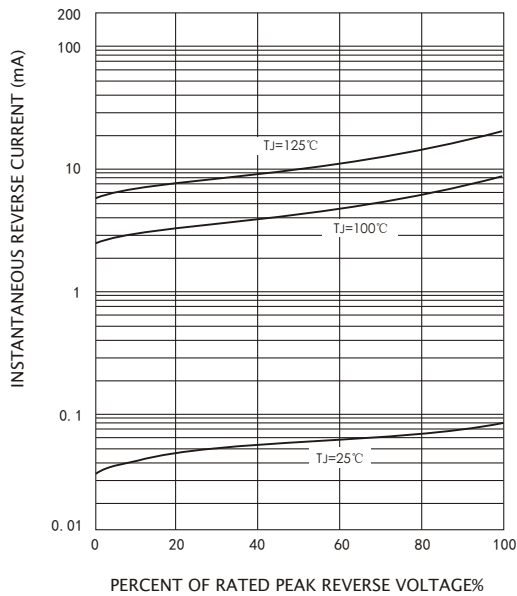
**FIG.1-TYPICAL FORWARD CURRENT DERATING CURVE**



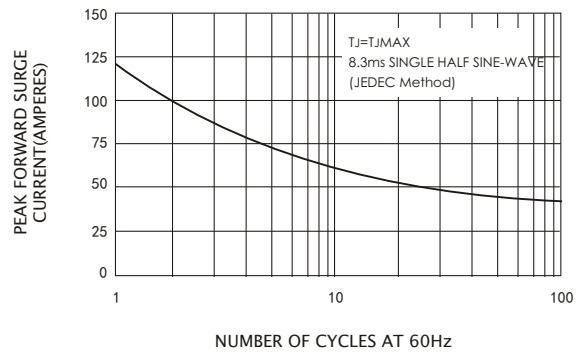
**FIG.2-TYPICAL FORWARD CHARACTERISTICS**



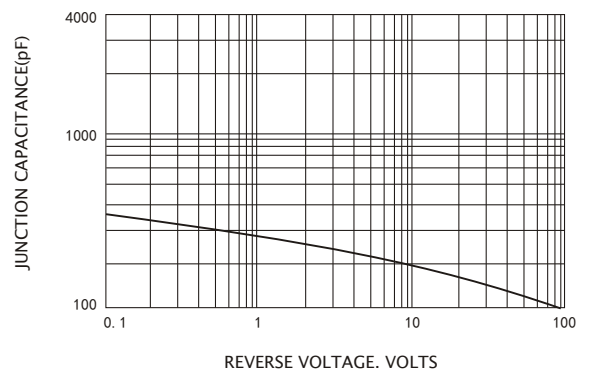
**FIG.3 - TYPICAL REVERSE CHARACTERISTICS**



**FIG.4-MAXIMUM NON-REPETITIVE FORWARD SURGE CURRENT**

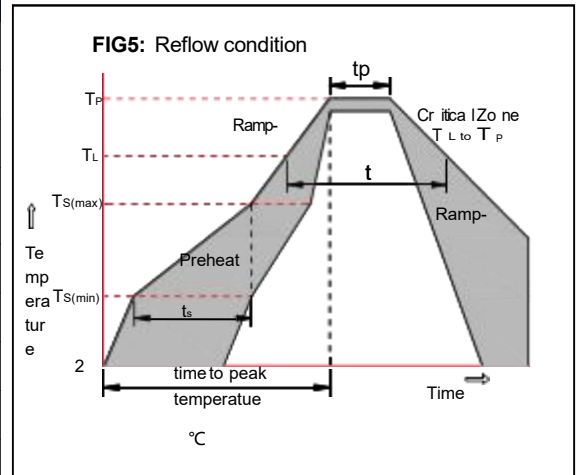


**FIG.5-TYPICAL JUNCTION CAPACITANCE**



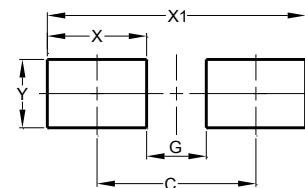
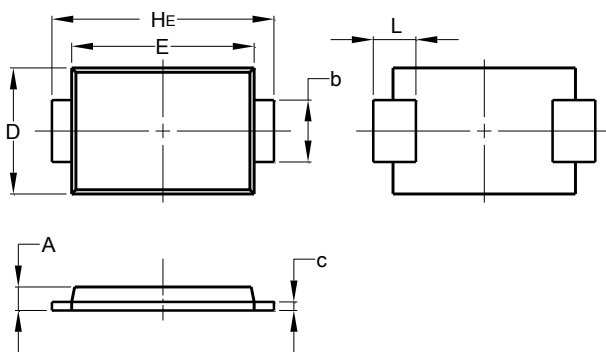
**Soldering parameters**

Reflow Condition		Pb-Free assembly (see as below)
Pre Heat	-Temperature Min ( $T_{s(min)}$ )	+150°C
	-Temperature Max( $T_{s(max)}$ )	+200°C
	-Time (Min to Max) (ts)	60-180 secs.
Average ramp up rate (Liquid us Temp ( $T_L$ ) to peak)		3°C/sec. Max
$T_{s(max)}$ to $T_L$ - Ramp-up Rate		3°C/sec. Max
Reflow	-Temperature( $T_L$ )(Liquid us)	+217°C
	-Temperature( $t_L$ )	60-150 secs.
Peak Temp ( $T_P$ )		+260(+0/-5)°C
Time within 5°C of actual Peak Temp ( $t_p$ )		30 secs. Max
Ramp-down Rate		6°C/sec. Max
Time 25°C to Peak Temp ( $T_P$ )		8 min. Max
Do not exceed		+260°C



**Package Dimensions & Suggested Pad Layout**

**SMAF**



SMAF		
Dim	Min	Max
A	0.90	1.20
b	1.30	1.60
c	0.10	0.20
D	2.40	2.70
E	3.30	3.70
HE	4.40	4.90
L	0.60	1.20
All Dimensions in mm		

Dimensions	Value (in mm)
C	3.80
G	2.20
X	1.60
X1	5.40
Y	1.70

Tape & reel specification

Tape		Symbol	Dimension (mm)		
		P0	4.00±0.20		
		P1	4.00±0.20		
		P2	2.00±0.20		
		D0	1.55±0.25		
		D1	1.55±0.25		
		E	1.75±0.20		
		F	5.50±0.20		
		W	12.00±0.20		
		A0	2.85±0.20		
		B0	5.00±0.20		
		K0	1.45±0.20		
		T	0.26±0.10		
		7" Reel		D2	176.0±5.0
				D3	55.0Min.
D4	14.0±2.5				
W1	14.0±2.5				
Quantity: 3000PCS					
13" Reel				D5	330.0±5.0
		D6	73.0Min.		
		D7	14.0±2.5		
		W2	14.0±2.5		
		Quantity: 10000PCS			