

## FEATURES

- \* Ideal for surface mount applications
- \* Easy pick and place
- \* Built-in strain relief
- \* Low forward voltage drop

## MECHANICAL DATA

- \* Case: Molded plastic
- \* Epoxy: UL 94V-0 rate flame retardant
- \* Metallurgically bonded construction
- \* Polarity: Color band denotes cathode end
- \* Mounting position: Any

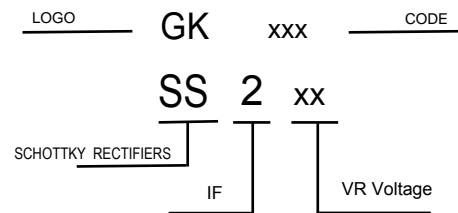


## VOLTAGE RANGE

20 to 100 Volts

## CURRENT

2.0 Ampere



## MAXIMUM RATINGS AND ELECTRICAL CHARACTERISTICS

Rating 25°C ambient temperature unless otherwise specified.  
Single phase half wave, 60Hz, resistive or inductive load.  
For capacitive load, derate current by 20%.

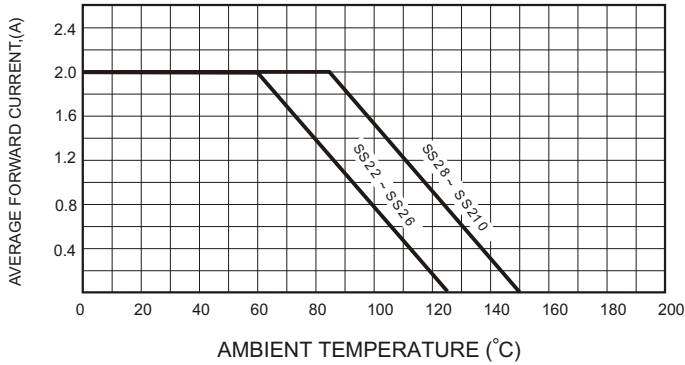
TYPE NUMBER	SS22	SS23	SS24	SS25	SS26	SS28	SS29	SS210	UNITS
Maximum Recurrent Peak Reverse Voltage	20	30	40	50	60	80	90	100	V
Maximum RMS Voltage	14	21	28	35	42	56	63	70	V
Maximum DC Blocking Voltage	20	30	40	50	60	80	90	100	V
Maximum Average Forward Rectified Current See Fig. 1	2.0								A
Peak Forward Surge Current, 8.3 ms single half sine-wave superimposed on rated load (JEDEC method)	50								A
Maximum Instantaneous Forward Voltage at 2.0A	0.55		0.70		0.85				V
Maximum DC Reverse Current $T_a=25^\circ\text{C}$	0.2								mA
at Rated DC Blocking Voltage $T_a=100^\circ\text{C}$	20								mA
Typical Junction Capacitance (Note 1)	170								pF
Typical Thermal Resistance $R_{JA}$ (Note 2)	75								$^\circ\text{C}/\text{W}$
Operating Temperature Range $T_j$	-65 — +125				-65 — +150				$^\circ\text{C}$
Storage Temperature Range $T_{stg}$	-65 — +150								$^\circ\text{C}$

### NOTES:

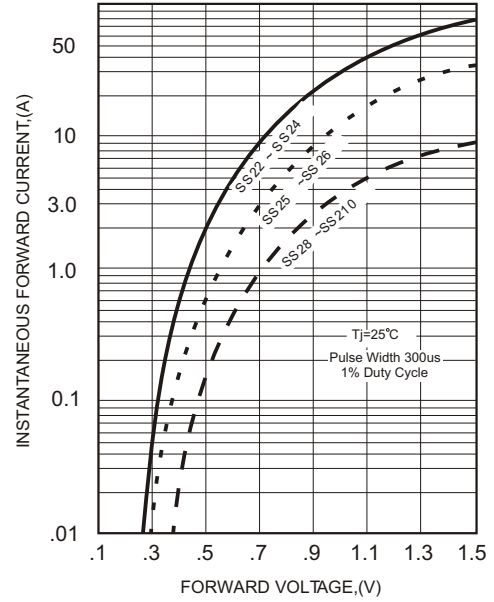
1. Measured at 1MHz and applied reverse voltage of 4.0V D.C.
2. Thermal Resistance Junction to Ambient.

**RATING AND CHARACTERISTIC CURVES**

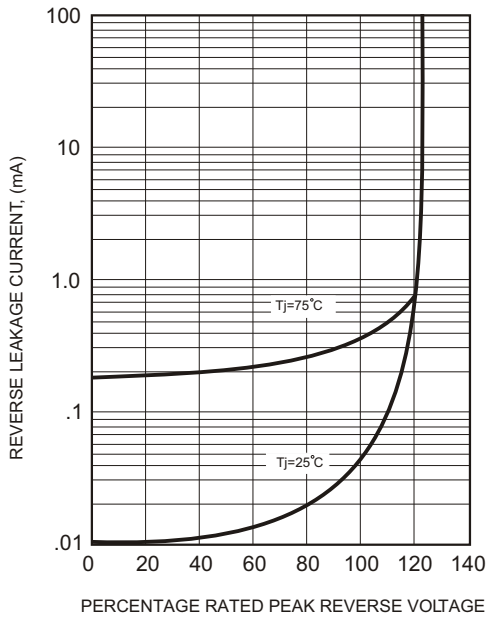
**FIG.1-TYPICAL FORWARD CURRENT DERATING CURVE**



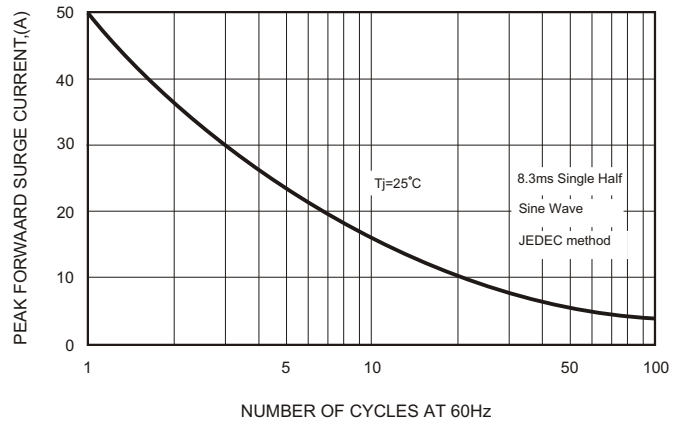
**FIG.2-TYPICAL FORWARD CHARACTERISTICS**



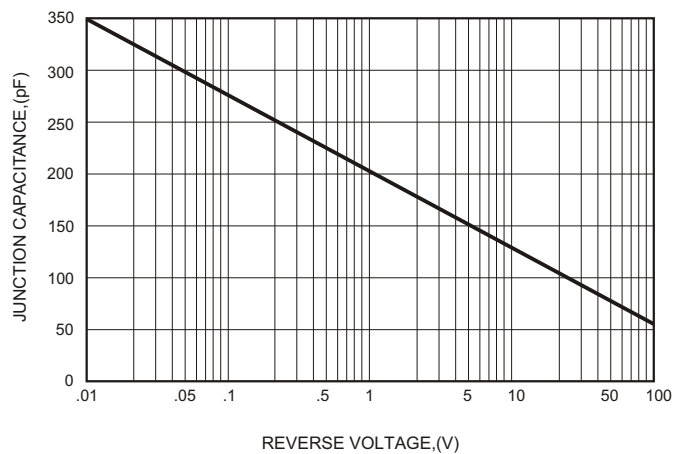
**FIG.3 - TYPICAL REVERSE CHARACTERISTICS**



**FIG.4-MAXIMUM NON-REPETITIVE FORWARD SURGE CURRENT**

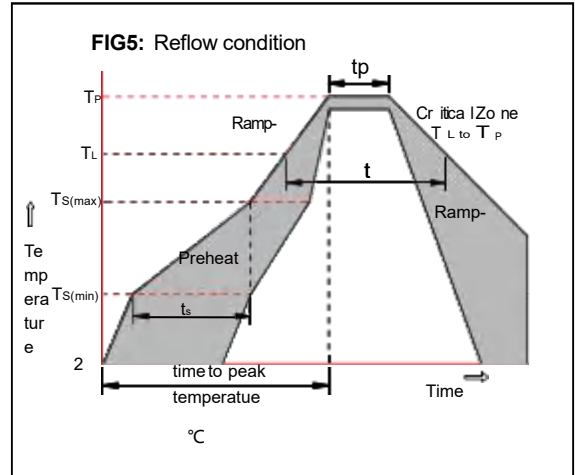


**FIG.5-TYPICAL JUNCTION CAPACITANCE**



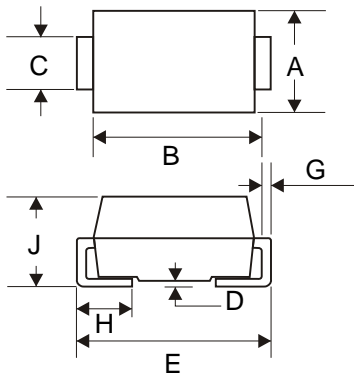
Soldering parameters

Reflow Condition		Pb-Free assembly (see as below)
Pre Heat	-Temperature Min ( $T_{s(min)}$ )	+150 °C
	-Temperature Max ( $T_{s(max)}$ )	+200 °C
	-Time (Min to Max) (ts)	60-180 secs.
Average ramp up rate (Liquid us Temp ( $T_L$ ) to peak)		3 °C/sec. Max
$T_{s(max)}$ to $T_L$ - Ramp-up Rate		3 °C/sec. Max
Reflow	-Temperature ( $T_L$ ) (Liquid us)	+217 °C
	-Temperature ( $t_L$ )	60-150 secs.
Peak Temp ( $T_P$ )		+260(+0/-5) °C
Time within 5 °C of actual Peak Temp ( $t_p$ )		30 secs. Max
Ramp-down Rate		6 °C/sec. Max
Time 25 °C to Peak Temp ( $T_P$ )		8 min. Max
Do not exceed		+260 °C

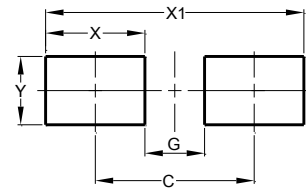


Package Dimensions & Suggested Pad Layout

SMA



SMA		
Dim	Min	Max
A	2.40	2.79
B	3.99	4.50
C	1.32	1.47
D	-	0.20
E	4.93	5.28
G	0.15	0.31
H	0.76	1.52
J	1.98	2.29
All Dimensions in mm		



Dimensions	Value (in mm)
C	4.20
G	1.90
X	2.30
X1	6.50
Y	2.00

Tape & reel specification

Tape		Symbol	Dimension (mm)		
		P0	4.00±0.20		
		P1	4.00±0.20		
		P2	2.00±0.20		
		D0	1.60±0.20		
		D1	1.60±0.20		
		E	1.75±0.20		
		F	5.50±0.15		
		W	12.00±0.25		
		A0	2.75±0.20		
		B0	5.25±0.20		
		K0	2.45±0.25		
		T	0.20±0.10		
		7" Reel		D2	176.0±5.0
				D3	55.0Min.
D4	14.0±2.5				
W1	14.0±2.5				
Quantity: 2000PCS					
13" Reel				D8	330.0±5.0
		D9	73.0Min.		
		D10	14.0±2.5		
		W3	14.0±2.5		
		Quantity: 5000PCS			