

FEATURES

- * Ideal for surface mount applications
- * Easy pick and place
- * Built-in strain relief
- * Super fast recovery time for high speed switching

MECHANICAL DATA

- * Case: Molded plastic
- * Epoxy: UL 94V-0 rate flame retardant
- * Metallurgically bonded construction
- * Polarity: Color band denotes cathode end
- * Mounting position: Any
- * Weight: 0.063 gram



VOLTAGE RANGE

800 Volts
CURRENT
2.0 Ampere

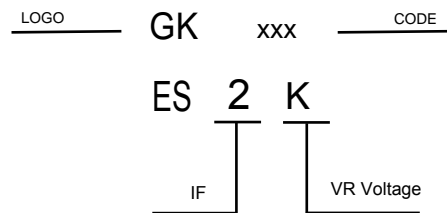

MAXIMUM RATINGS AND ELECTRICAL CHARACTERISTICS

Rating 25°C ambient temperature unless otherwise specified.
Single phase half wave, 60Hz, resistive or inductive load.
For capacitive load, derate current by 20%.

TYPE NUMBER	ES2K	UNITS
Maximum Recurrent Peak Reverse Voltage	800	V
Maximum RMS Voltage	560	V
Maximum DC Blocking Voltage	800	V
Maximum Average Forward Rectified Current	2.0	A
Peak Forward Surge Current, 8.3 ms single half sine-wave superimposed on rated load (JEDEC method)	60	A
Maximum Instantaneous Forward Voltage at 2.0A	1.9	V
Maximum DC Reverse Current Ta=25°C	5.0	uA
at Rated DC Blocking Voltage Ta=100°C	50	uA
Maximum Reverse Recovery Time (Note 1)	35	nS
Typical Junction Capacitance (Note 2)	40	pF
Operating and Storage Temperature Range T _J , T _{STG}	-65 — +150	°C

NOTES:

1. Reverse Recovery Time test condition: IF=0.5A, IR=1.0A, IRR=0.25A
2. Measured at 1MHz and applied reverse voltage of 4.0V D.C.

RATING AND CHARACTERISTIC CURVES

FIG.1-TYPICAL FORWARD CURRENT DERATING CURVE

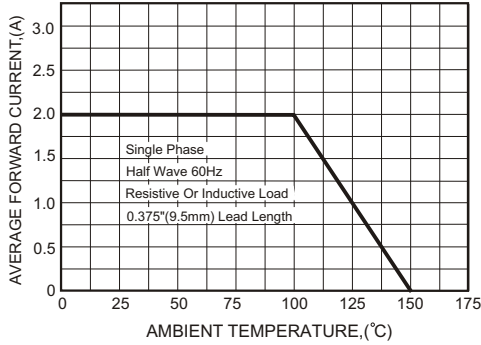

FIG.2-TYPICAL FORWARD CHARACTERISTICS

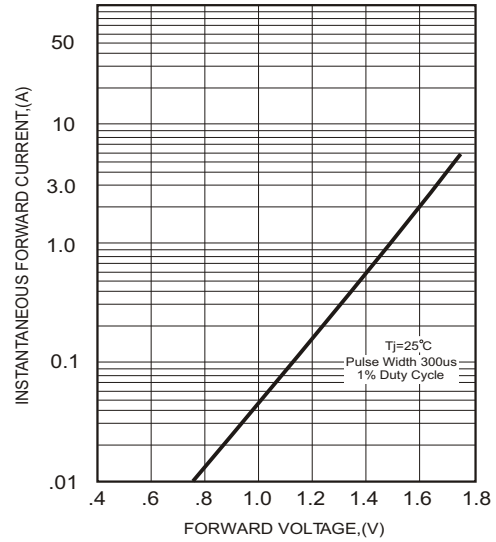
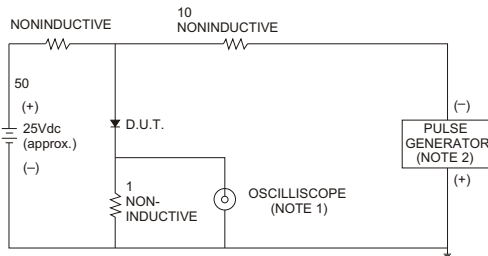

FIG.3- TEST CIRCUIT DIAGRAM AND REVERSE RECOVERY TIME CHARACTERISTICS



NOTES: 1. Rise Time= 7ns max., Input Impedance= 1 megohm.22pF.
2. Rise Time= 10ns max., Source Impedance= 50 ohms.



FIG.4-MAXIMUM NON-REPETITIVE FORWARD SURGE CURRENT

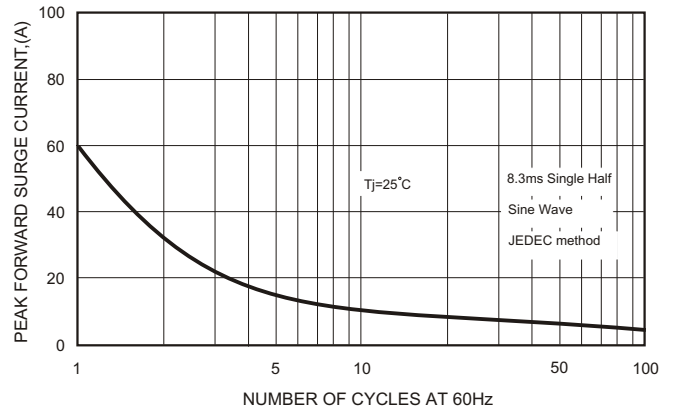

FIG.5- TYPICAL REVERSE CHARACTERISTICS

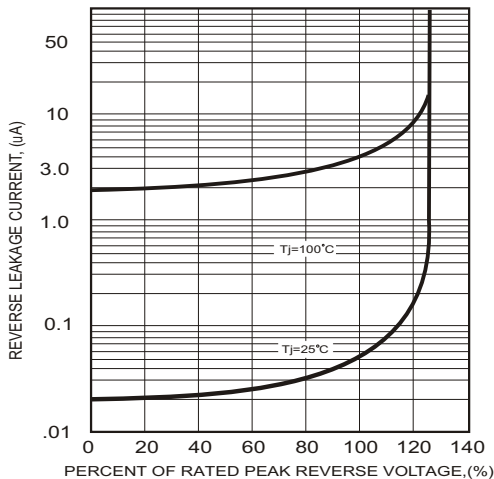
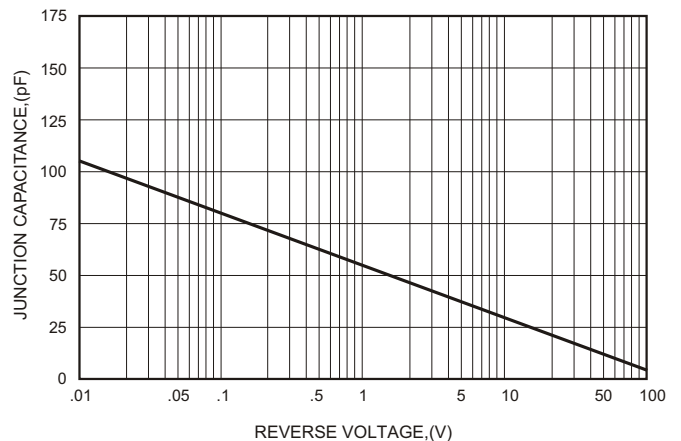

FIG.6-TYPICAL JUNCTION CAPACITANCE



Soldering parameters

Reflow Condition		Pb-Free assembly (see as below)
Pre Heat	-Temperature Min ($T_{s(min)}$)	+150 °C
	-Temperature Max($T_{s(max)}$)	+200 °C
	-Time (Min to Max) (ts)	60-180 secs.
Average ramp up rate (Liquid us Temp (T_L) to peak)		3 °C/sec. Max
$T_{s(max)}$ to T_L - Ramp-up Rate		3 °C/sec. Max
Reflow	-Temperature(T_L)(Liquid us)	+217 °C
	-Temperature(t_L)	60-150 secs.
Peak Temp (T_P)		+260(+0/-5) °C
Time within 5 °C of actual Peak Temp (t_p)		30 secs. Max
Ramp-down Rate		6 °C/sec. Max
Time 25 °C to Peak Temp (T_P)		8 min. Max
Do not exceed		+260 °C



Package Dimensions & Suggested Pad Layout

SMA

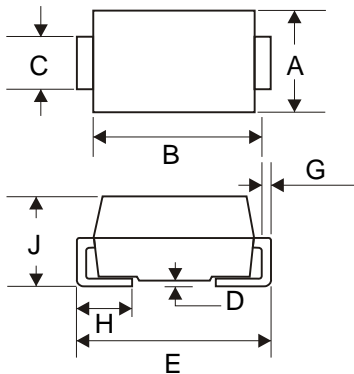

SMA		
Dim	Min	Max
A	2.40	2.79
B	3.99	4.50
C	1.32	1.47
D	-	0.20
E	4.93	5.28
G	0.15	0.31
H	0.76	1.52
J	1.98	2.29
All Dimensions in mm		

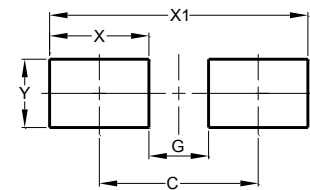

Dimensions	Value (in mm)
C	4.20
G	1.90
X	2.30
X1	6.50
Y	2.00

Tape & reel specification

Tape		Symbol	Dimension (mm)
		P0	4.00±0.20
		P1	4.00±0.20
		P2	2.00±0.20
		D0	1.60±0.20
		D1	1.60±0.20
		E	1.75±0.20
		F	5.50±0.15
		W	12.00±0.25
		A0	2.75±0.20
		B0	5.25±0.20
		K0	2.45±0.25
		T	0.20±0.10
7" Reel		D2	176.0±5.0
		D3	55.0Min.
		D4	14.0±2.5
		W1	14.0±2.5
		Quantity: 2000PCS	
13" Reel		D8	330.0±5.0
		D9	73.0Min.
		D10	14.0±2.5
		W3	14.0±2.5
		Quantity: 5000PCS	